

Idle Stepper Motor Control Type 1

Harness Required: S01 Ver 1.0

Last Changed: 16/02/2011

Drawing Ver: 1.1

Connection Schematic

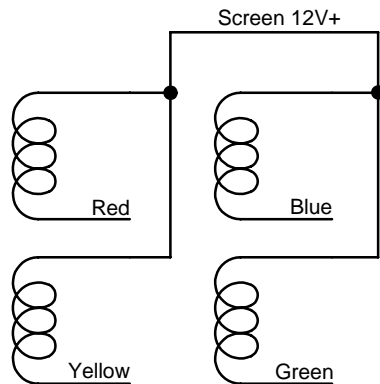

4 x Coils with common wire

Do Not use this idle control if coil resistance is less than 20 ohm !!!

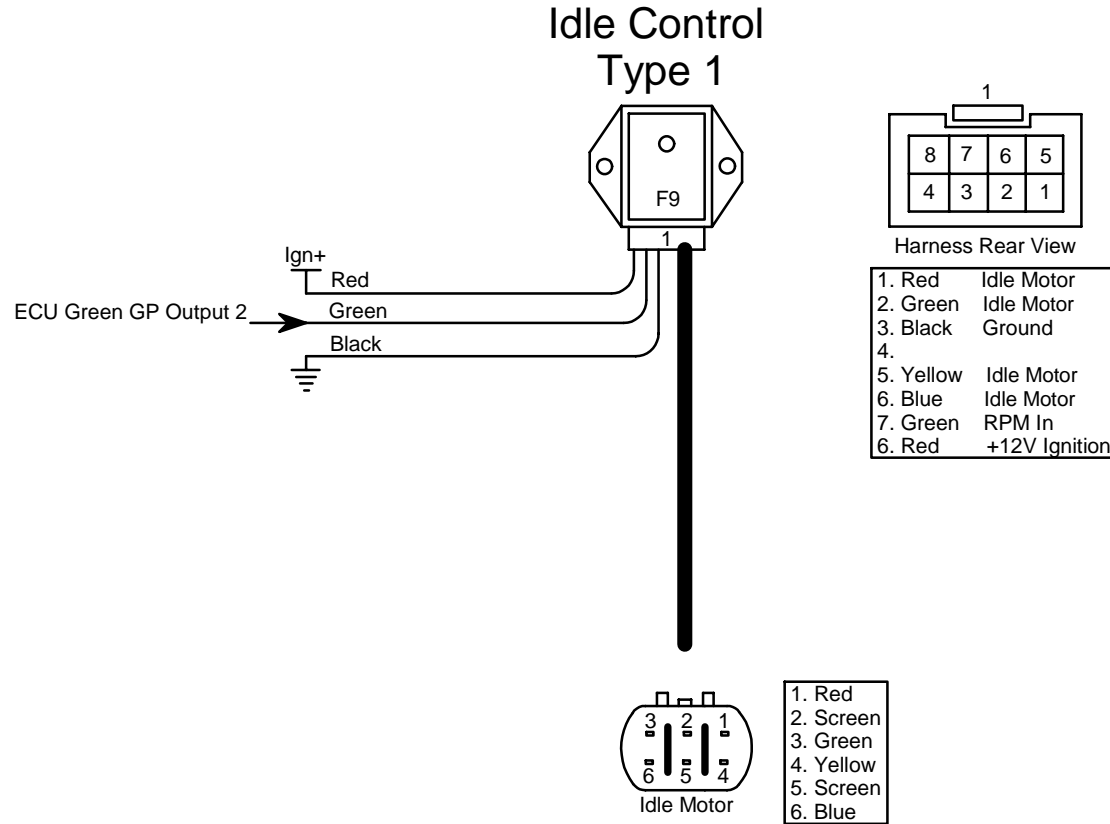

Do Not Earth the Screen as it carries 12V+ !!!