

Pluto Fan Controller

Last Changed: 09/04/2020

GP1 PWM Fan

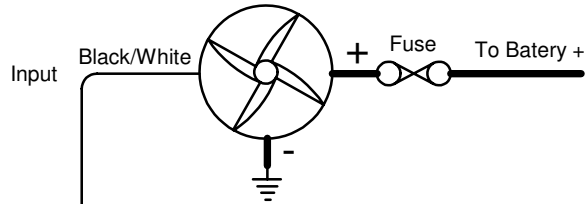

To Program the unit place J1 and J2 in the up position.

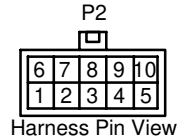
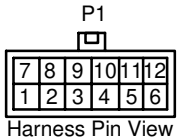
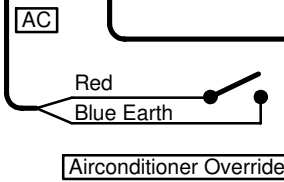
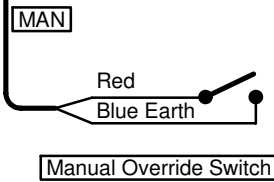
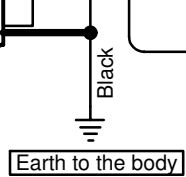
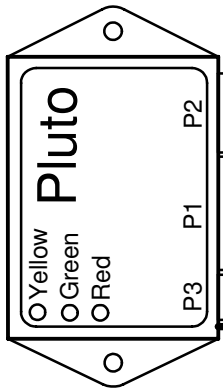

- 1.
- 2.
- 3. Blue - Water Tap In
- 4. Black - GND
- 5.
- 6.
- 7. Red - Water Standalone
- 8.
- 9.
- 10. Orange - +12V Ign Input
- 11. Red - Man Override
- 12. Red - Aircon Override

Connector Pinouts

- 1.
- 2. Black/Orange - GP3
- 3. Black/White - GP1 PWM Fan
- 4.
- 5.
- 6.
- 7.
- 8. Black/Yellow - GP2
- 9.
- 10.

Connector Pinouts

Ign+
 Ignition Power
 Earth
Terminal Connections with the same name are tied together

Led's Functions
 Yellow - Power
 Green - PWM Fan Active
 Red - Override Active

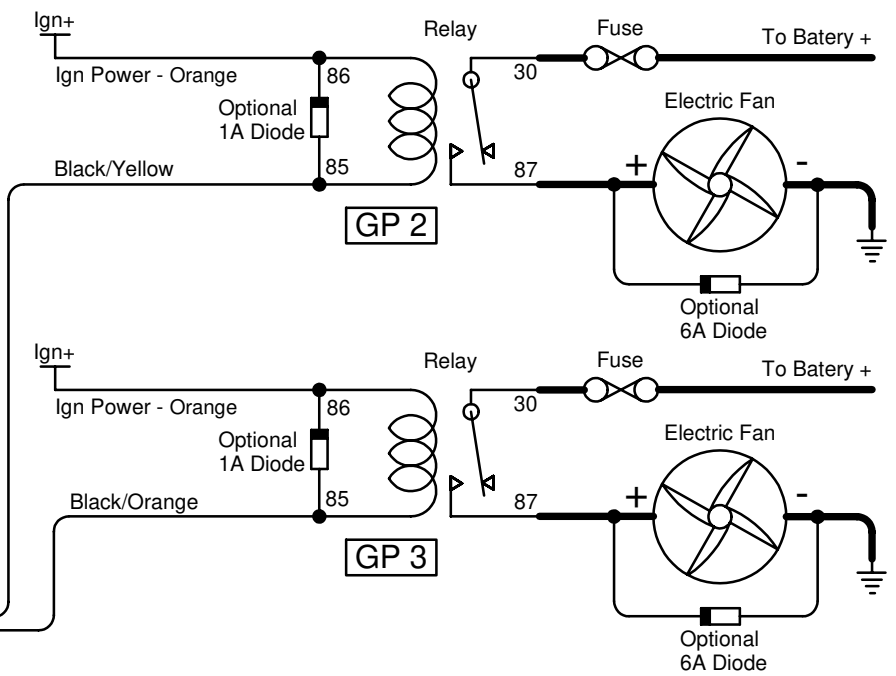

Temperature Sensor

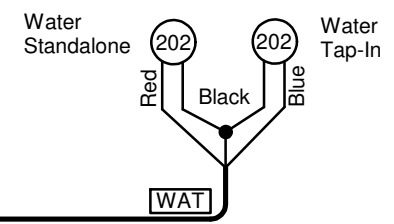

Pluto Fan Controller

Last Changed: 09/04/2020

GP1 PWM Fan

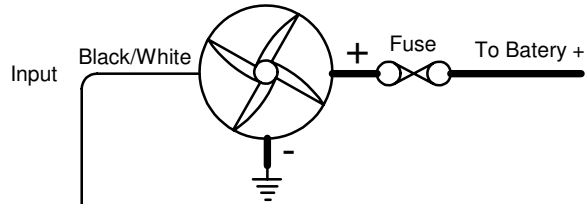

Jumper Settings

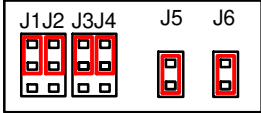

To Program the unit place J1 and J2 in the up position.

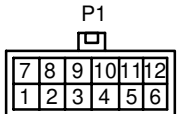
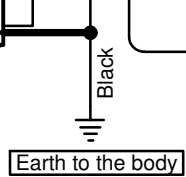
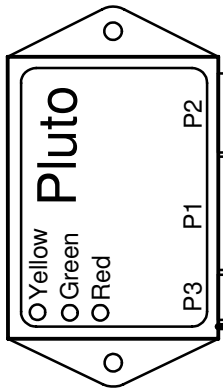

- | | |
|-----|-------------------------|
| 1. | |
| 2. | |
| 3. | Blue - Water Tap In |
| 4. | Black - GND |
| 5. | |
| 6. | |
| 7. | Red - Water Standalone |
| 8. | |
| 9. | |
| 10. | Orange - +12V Ign Input |
| 11. | Red - Man Override |
| 12. | Red - Aircon Override |

Connector Pinouts

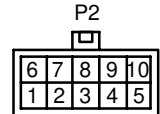

- | | |
|-----|---------------------------|
| 1. | |
| 2. | Black/Orange - GP3 |
| 3. | Black/White - GP1 PWM Fan |
| 4. | |
| 5. | |
| 6. | |
| 7. | |
| 8. | Black/Yellow - GP2 |
| 9. | |
| 10. | |

Connector Pinouts

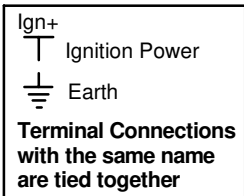

- Led's Functions**
- Yellow - Power
 - Green - PWM Fan Active
 - Red - Override Active

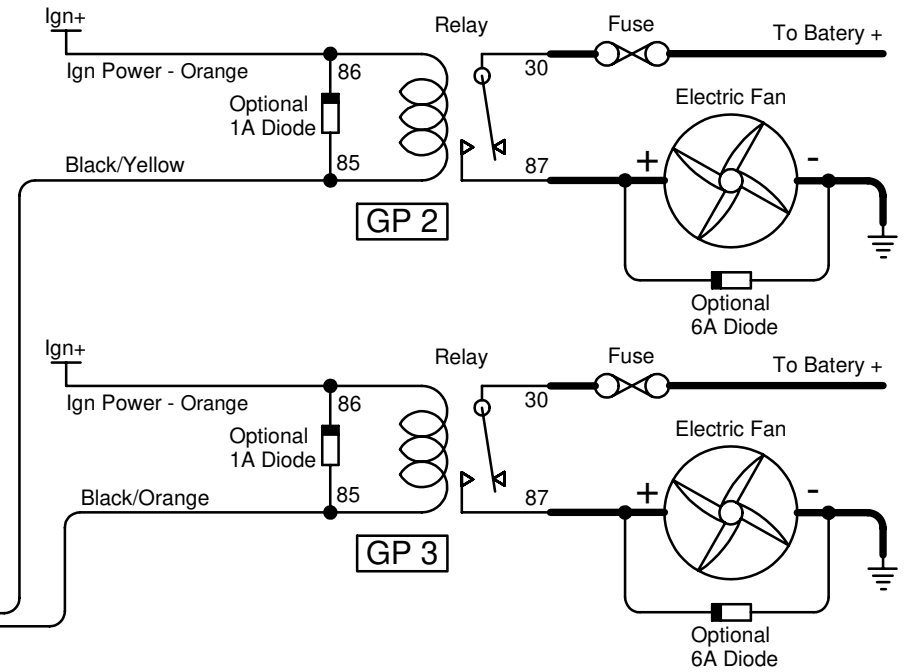

Temperature Sensor

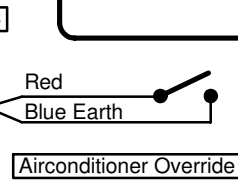
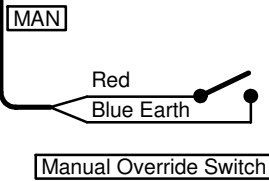
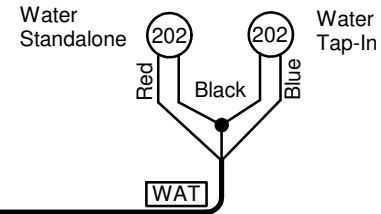

Pluto Fan Controller

Last Changed: 09/04/2020

GP1 PWM Fan

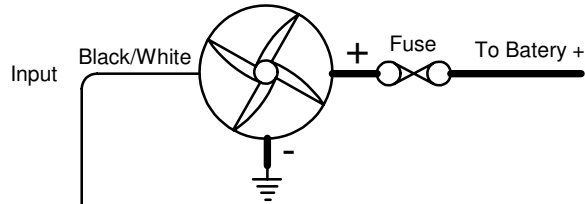

Jumper Settings

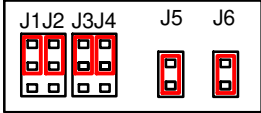

To Program the unit place J1 and J2 in the up position.

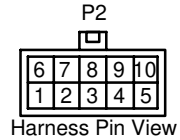
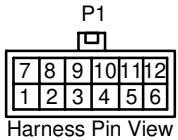
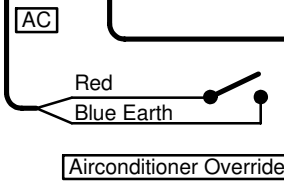
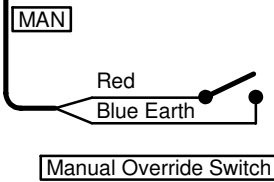
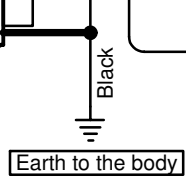
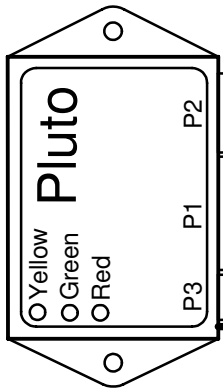

- 1.
- 2.
- 3. Blue - Water Tap In
- 4. Black - GND
- 5.
- 6.
- 7. Red - Water Standalone
- 8.
- 9.
- 10. Orange - +12V Ign Input
- 11. Red - Man Override
- 12. Red - Aircon Override

Connector Pinouts

- 1.
- 2. Black/Orange - GP3
- 3. Black/White - GP1 PWM Fan
- 4.
- 5.
- 6.
- 7.
- 8. Black/Yellow - GP2
- 9.
- 10.

Connector Pinouts

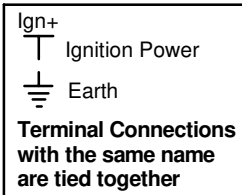

- Led's Functions**
- Yellow - Power
 - Green - PWM Fan Active
 - Red - Override Active

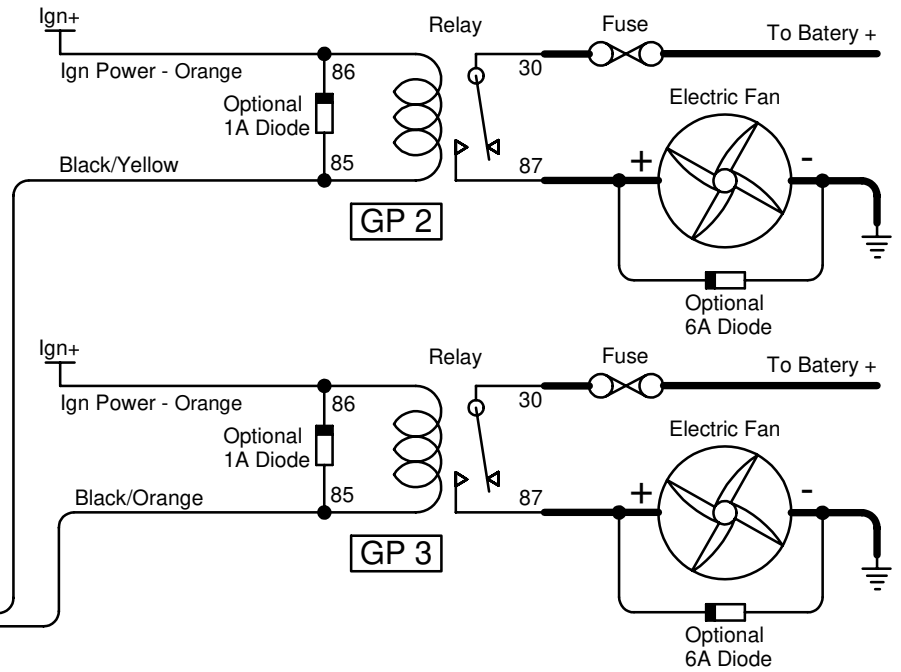

Temperature Sensor

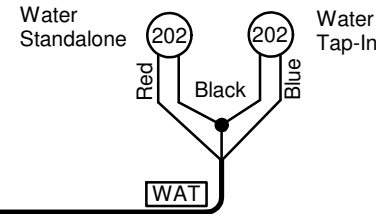

Pluto Fan Controller

Last Changed: 09/04/2020

GP1 PWM Fan

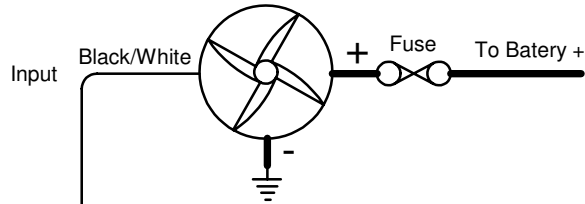

Jumper Settings

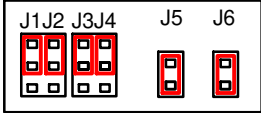

To Program the unit place J1 and J2 in the up position.

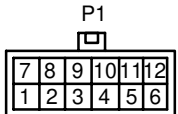
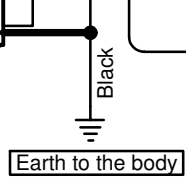
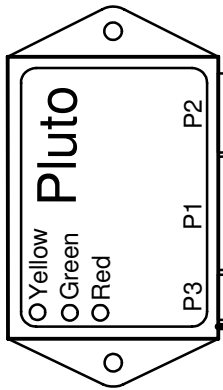

- | | | | | | |
|---|---|---|----|----|----|
| 7 | 8 | 9 | 10 | 11 | 12 |
| 1 | 2 | 3 | 4 | 5 | 6 |
- 1.
 - 2.
 - 3. Blue - Water Tap In
 - 4. Black - GND
 - 5.
 - 6.
 - 7. Red - Water Standalone
 - 8.
 - 9.
 - 10. Orange - +12V Ign Input
 - 11. Red - Man Override
 - 12. Red - Aircon Override

Connector Pinouts

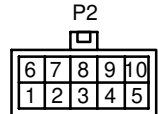

- 1.
- 2. Black/Orange - GP3
- 3. Black/White - GP1 PWM Fan
- 4.
- 5.
- 6.
- 7.
- 8. Black/Yellow - GP2
- 9.
- 10.

Connector Pinouts

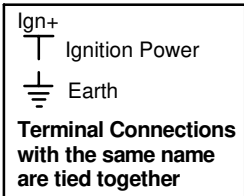

- Led's Functions**
- Yellow - Power
 - Green - PWM Fan Active
 - Red - Override Active

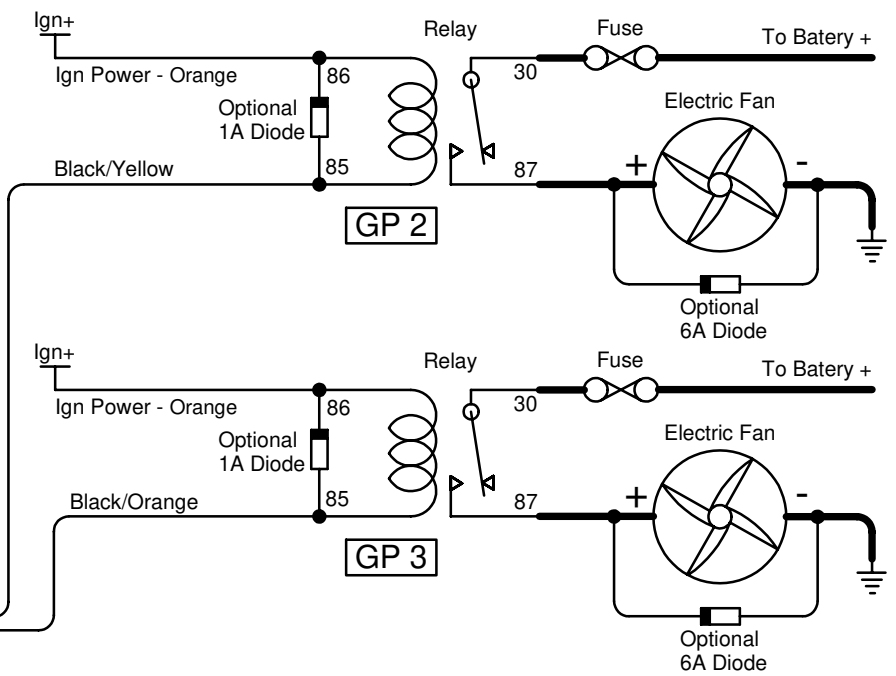

Temperature Sensor

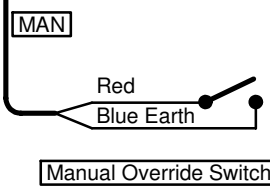
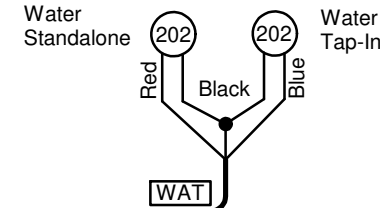

Manual Override Switch

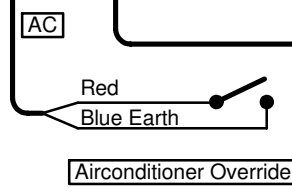

Airconditioner Override

Pluto Fan Controller

Last Changed: 09/04/2020

GP1 PWM Fan

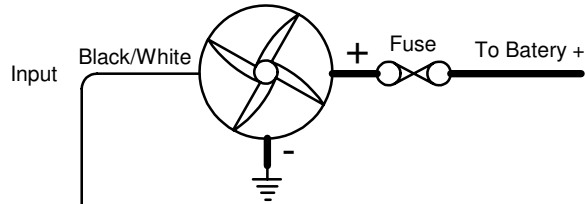

Jumper Settings

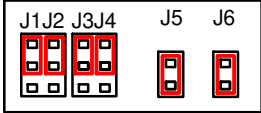

To Program the unit place J1 and J2 in the up position.

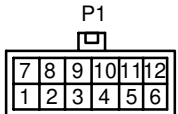
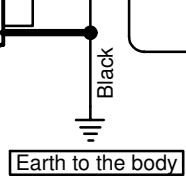
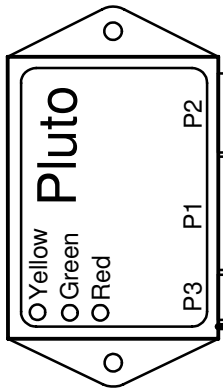

- 1.
- 2.
- 3. Blue - Water Tap In
- 4. Black - GND
- 5.
- 6.
- 7. Red - Water Standalone
- 8.
- 9.
- 10. Orange - +12V Ign Input
- 11. Red - Man Override
- 12. Red - Aircon Override

Connector Pinouts

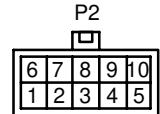

- 1.
- 2. Black/Orange - GP3
- 3. Black/White - GP1 PWM Fan
- 4.
- 5.
- 6.
- 7.
- 8. Black/Yellow - GP2
- 9.
- 10.

Connector Pinouts

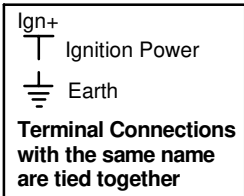

- Led's Functions**
- Yellow - Power
 - Green - PWM Fan Active
 - Red - Override Active

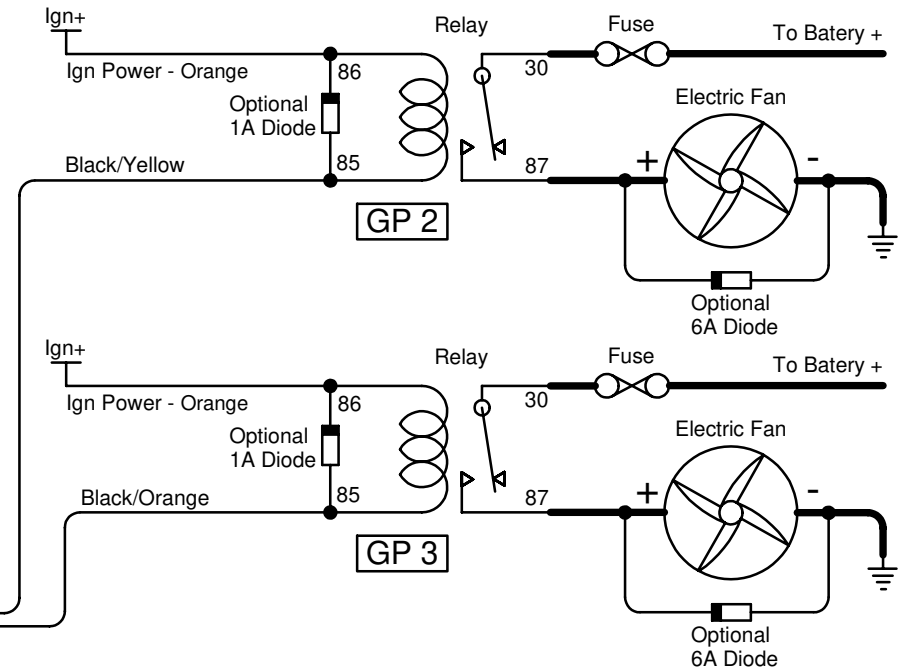

Temperature Sensor

