

# A761E FreeWheel Diode

Last Changed: 23/08/2019

**Note:** If you use level 1 harness, or manufacture your own harness, then you need to install the DB1 or DB2 boards. If you dont have these boards you may install single diodes into the lines for all the PWM solenoids. Use this schematic as a guideline.

**NB!!** The Diode must be connected.  
Make sure the stripe on the diode is facing  
the positive of the Driver.

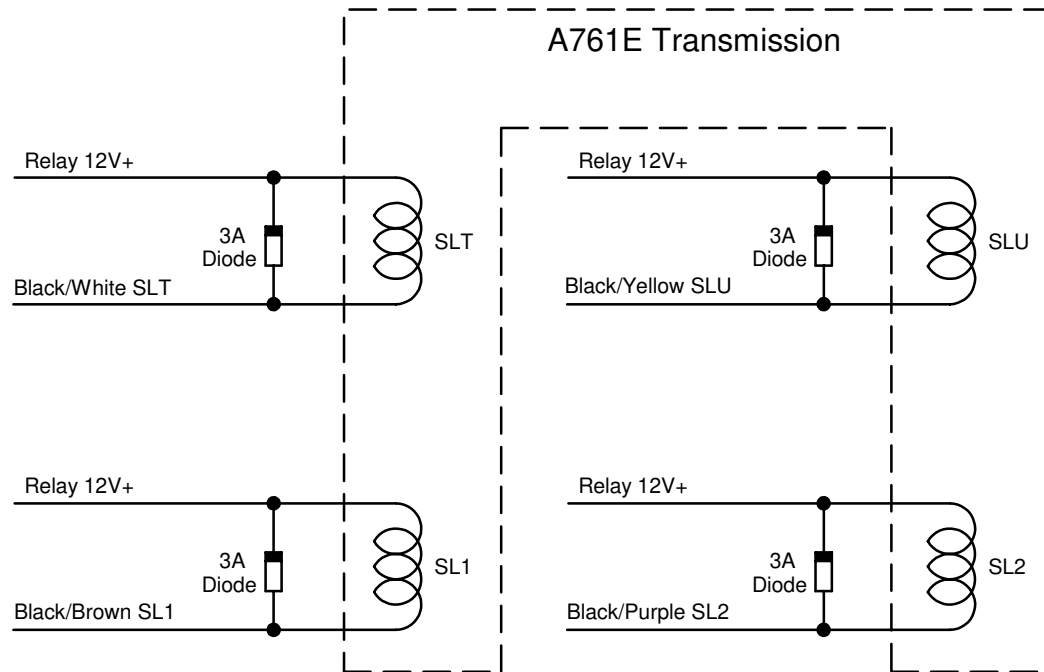

# A761E FreeWheel Diode

Last Changed: 23/08/2019

**Note:** If you use level 1 harness, or manufacture your own harness, then you need to install the DB1 or DB2 boards. If you dont have these boards you may install single diodes into the lines for all the PWM solenoids. Use this schematic as a guideline.

**NB!!** The Diode must be connected.  
Make sure the stripe on the diode is facing  
the positive of the Driver.

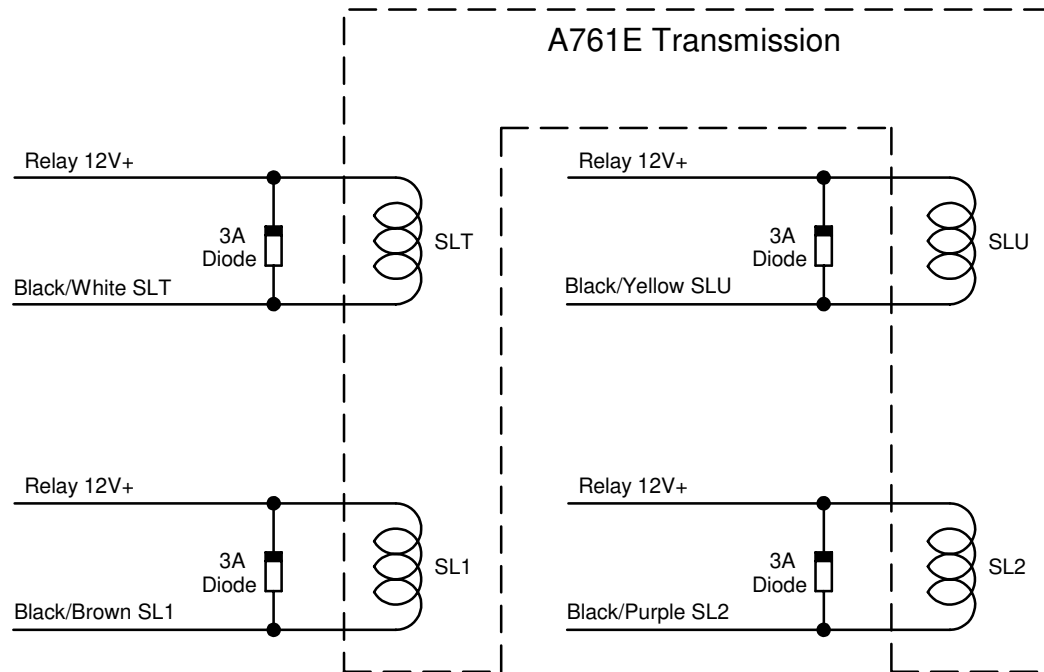

# A761E FreeWheel Diode

Last Changed: 23/08/2019

**Note:** If you use level 1 harness, or manufacture your own harness, then you need to install the DB1 or DB2 boards. If you dont have these boards you may install single diodes into the lines for all the PWM solenoids. Use this schematic as a guideline.

**NB!!** The Diode must be connected.  
Make sure the stripe on the diode is facing  
the positive of the Driver.

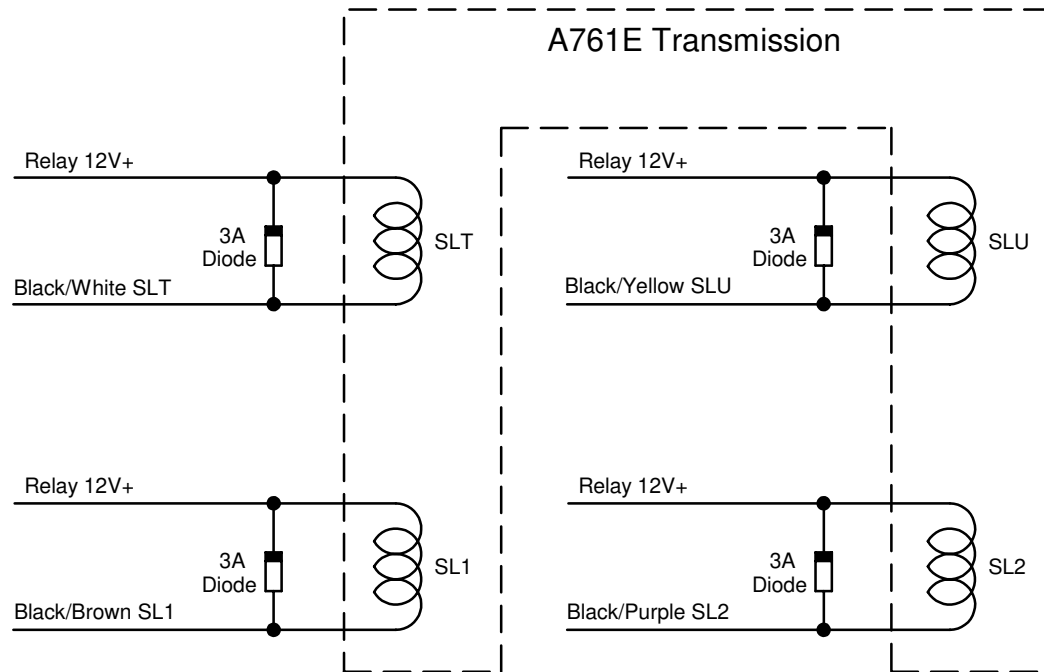

# A761E FreeWheel Diode

Last Changed: 23/08/2019

**Note:** If you use level 1 harness, or manufacture your own harness, then you need to install the DB1 or DB2 boards. If you dont have these boards you may install single diodes into the lines for all the PWM solenoids. Use this schematic as a guideline.

**NB!!** The Diode must be connected.  
Make sure the stripe on the diode is facing  
the positive of the Driver.

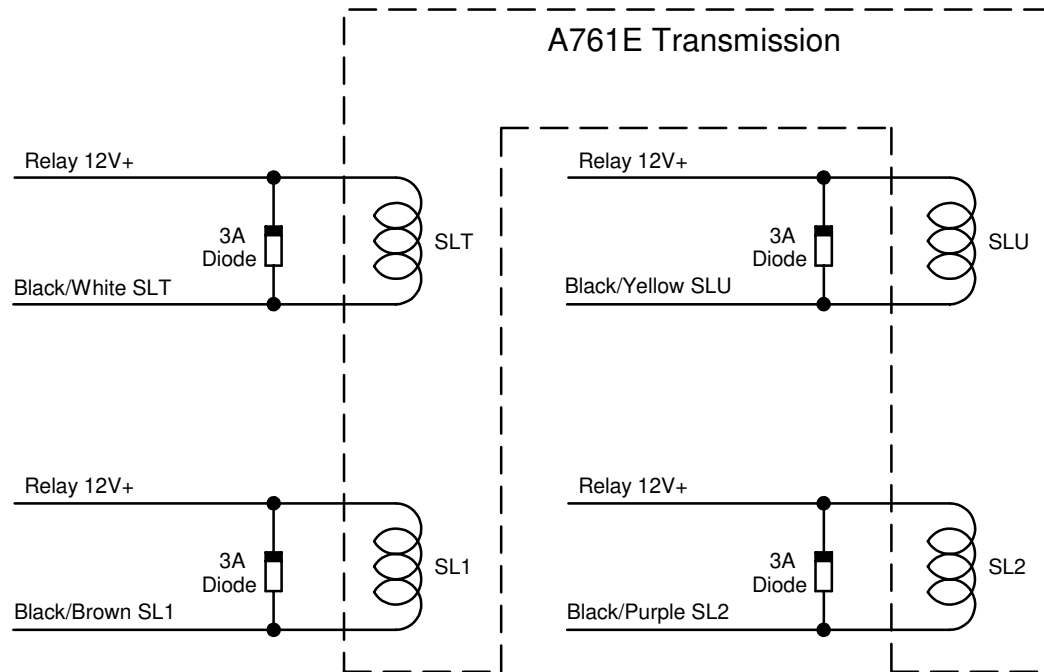

# A761E FreeWheel Diode

Last Changed: 23/08/2019

**Note:** If you use level 1 harness, or manufacture your own harness, then you need to install the DB1 or DB2 boards. If you dont have these boards you may install single diodes into the lines for all the PWM solenoids. Use this schematic as a guideline.

**NB!!** The Diode must be connected.  
Make sure the stripe on the diode is facing  
the positive of the Driver.

